

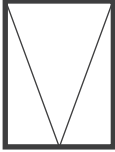

Size Code	O/A Reveal Size (mm)	04	06	09	12	12	15	18	21	24	18	21	24	27	
05	514	450	610	850	1210	1210	1450	1810	2170	2398	1810	2170	2398	2704	
09	854														
10	1027														
12	1200														
14	1372														
15	1543														
18	1800														
20	2057														
21	2110														
23	2315														

- Single Panel Wide Available (STD) Single Sash, or (FXD) All Fixed Panels
- 2 Panel Wide Available (STD) Opening Sash on Left, (REV) Opening Sash on Right, (FXD) All Panels Fixed, or (DS) Double Sash:

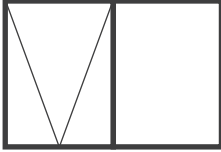

- 53mm Wideline Sash frame thickness as standard
- Double Glazing option for all available sizes above

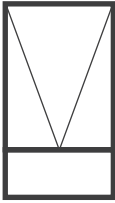
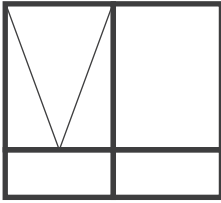
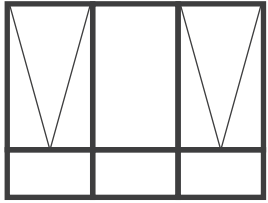
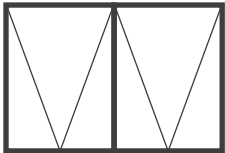
- 3 Panel Wide Available (STD) Equal Sash on Left and Right, (FXD) All Fixed Panels, (TS) Triple Sash (Standard Configuration Only), (SSS) Set Sash Sizes (sashes at a nominated standard width either 06 - 561mm or 15 - 687mm wide), or (QHQ) Quarter/Half/Quarter

(STD) Equal Sash on Left and Right:

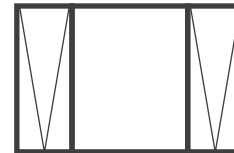

# Boutique Awning Windows

Code Prefix: WAAW Suite: BTP

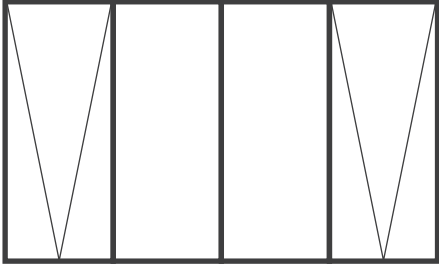
Size Code		15	18	21	24	27	30	36	40	48	
	O/A Reveal Size (mm)	1450	1810	2170	2410	2710	3010	3610	4000	4810	
05	514										
12	1200										
14	1372										
15	1543										

- Available (STD) Equal Panels, 1 Sash on Each Side, (DS) Double Centre Sashes, (QS) Quadruple Sash, or (FXD) All Fixed Panels
- 1450 Wide Only Available (FXD) All Fixed Panels
- 53mm Wideline Sash frame thickness as standard
- Double Glazing option for all available sizes above

 Not Available

# Boutique Georgian Awning Windows

Code Prefix: WAAW Suite: BTP - GS

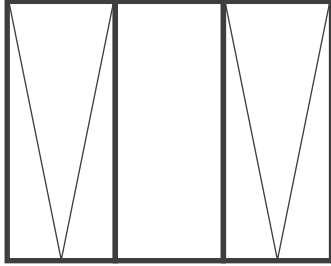
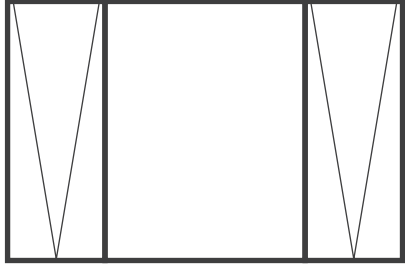
Size Code		09	12	18	21	24	27	30	36
O/A Reveal Size (mm)		850	1210	1810	2170	2410	2710	3010	3610
Sash Width (mm)		768	1128	384	474	534	609	684	834
10	1027								
12	1200								
14	1372								
15	1543								
18	1800								
20	2057								
23	2315								

- Single Panel Available (STD) Single Sash with GS Bar
- 3 Panel Wide Available (STD) Quarter/Half/Quarter

Code Prefix: WAAW Suite: BTP - GST

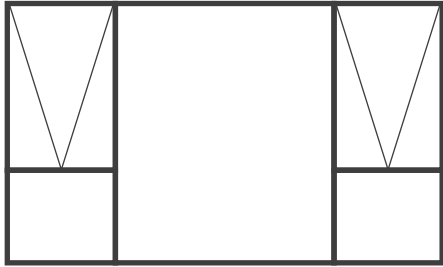
Size Code		18	21	24	27	30	36
O/A Reveal Size (mm)		1810	2170	2410	2710	3010	3610
Sash Width (mm)		384	474	534	609	684	834
18	1800						
20	2057						
23	2315						

- Available (STD) Quarter/Half/Quarter with Sash above Transom Left and Right, Full Height Fixed Panel in Centre
- 53mm Wideline Sash frame thickness as standard

 Size not available Double Glazed

# Boutique Armadale Awning Windows

Code Prefix: WAAW Suite: BTP - AR

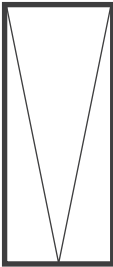
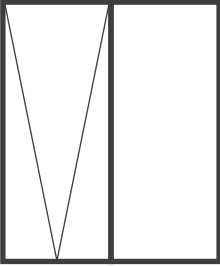
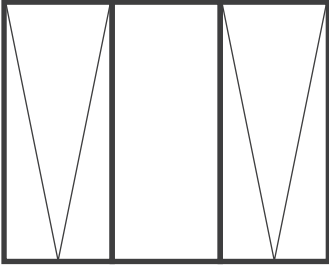
Size Code		04	06	09	12	09	12	15	18	21	24	15	18	21	24	27	30	36	
	O/A Reveal Size (mm)	450	610	850	1210	850	1210	1450	1810	2170	2410	1450	1810	2170	2410	2710	3010	3610	
18	1800																		
20	2057																		
21	2110																		
23	2315																		
24	2370																		

- Single Panel Available (STD) Single Sash
- 2 Panel Available (STD) Opening Sash on Left, (REV) Opening Sash on Right, or (DS) Double Sash
- 3 Panel Available (STD) Equal Panels, Sashes on Left and Right, (TS) Triple Sash, or (CS) Centre Sash
- 53mm Wideline Sash frame thickness as standard
- Double Glazing option for all available sizes above

# Boutique Armadale Awning Windows

Code Prefix: WAAW Suite: BTP - ART

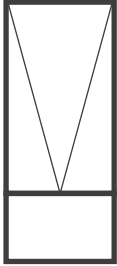
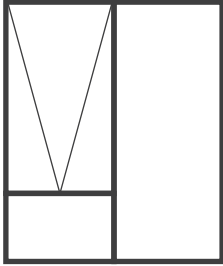
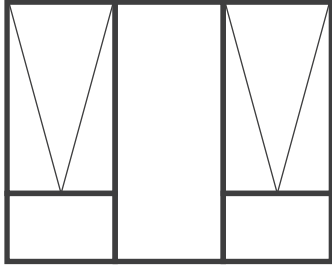
Size Code		04	06	09	12	09	12	15	18	21	24	15	18	21	24	27	30	36	
	O/A Reveal Size (mm)	450	610	850	1210	850	1210	1450	1810	2170	2410	1450	1810	2170	2410	2710	3010	3610	
18	1800																		
20	2057																		
21	2110																		
23	2315																		
24	2370																		

- Single Panel Wide Available (STD) Single Sash above Transom
- 2 Panel Wide Available (STD) Opening Sash above Transom on Left, (REV) Opening Sash above Transom on Right
- 3 Panel Wide Available (STD) Equal Panels with Sash on Left and Right above Transom
- 53mm Wideline Sash frame thickness as standard
- Double Glazing option for all available sizes above



# Boutique Offset (Metro) Awning Windows

Code Prefix: WAAW Suite: BTP - OS

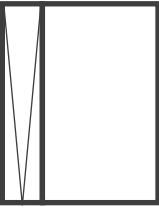
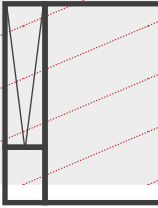
Code Prefix: WAAW Suite: BTP - OST







	Size Code	15	18	21	24	27	30	36	15	18	21	24	27	30
	O/A Reveal Size (mm)	1450	1810	2170	2410	2710	3010	3610	1450	1810	2170	2410	2710	3010
	Sash Width (mm)	414	534	654	734	834	934	1124	414	534	654	734	834	934
05	514													
10	1027													
12	1200													
14	1372													
15	1543													
18	1800													
20	2057													
23	2315													

- 1 Panel High Available (STD) Sash on Left, or (REV) Sash on Right
- 2 Panel High Available (STD) Sash on Left above Transom, (REV) Sash on Right above Transom
- 53mm Wideline Sash frame thickness as standard

-  Size not available Double Glazed
-  Not Available

# Boutique Multi Transom (Contempo) Awning Windows

Code Prefix: WAAW Suite: BTP - MT

Size Code		06	09	12	15	18	21	24	27
	O/A Reveal Size (mm)	610	850	1210	1450	1810	2170	2410	2710
05	514								
07	700								
10	1027								
12	1200								
14	1372								
14	1372								
15	1543								
18	1800								
20	2057								
20	2057								
23	2315								
24	2370								

- Single Panel High Available (STD) Single Sash, or (FXD) Fixed
- 2-4 Panel High Available with Sash or Fixed Panel in any position
- 53mm Wideline Sash frame thickness as standard
- Sashes 2170mm wide and above require catches fitted to jambs
- Double Glazing option for all available sizes above

 Not Available

# Boutique Multi Transom (Contempo) Awning Windows

Code Prefix: WAAW Suite: BTP - MT

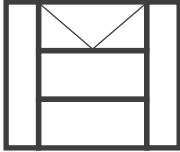
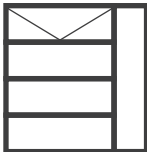
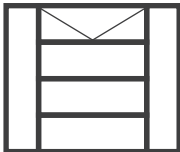
Size Code		21	24	27	27	27
O/A Reveal Size (mm)		2170	2410	2710	2710	2710
15	1543					
18	1800					
20	2057					
23	2315					

- 2 Panel Wide Available (STD) Sash Top Left with Full Height Fixed Panel Right, (REV) Sash Top Right with Full Height Fixed Panel Left
- 3 Panel Wide Available (STD) Sash Top Centre
- All Available with a Sash or Fixed Panel in any/all positions, excluding Fixed Sidelights
- 53mm Wideline Sash frame thickness as standard
- Double Glazing option for all available sizes above

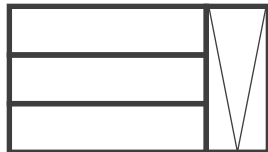

Sash Size in vertical position:

- Maximum 2315 high x 1210 wide
- Minimum 300 high x 450 wide



Sash Size in horizontal position:

- Maximum 700 high x 1810 wide
- Minimum 300 high x 450 wide



# Boutique Overlooking Awning Windows

Code Prefix: WAAW Suite: BTP - OL

Size Code			06	09	12	15	18	21	24	15	18	21	24	27		
	O/A Reveal Size (mm)	Sash Height (mm)	610	850	1210	1450	1810	2170	2398	1450	1810	2170	2398	2704		
10	1027	370														
12	1200															
14	1372															
15	1543															
18	1800															
20	2057															
23	2315															

- Single Panel Wide Available (STD) Single Sash, or (FXD) All Fixed Panels
- 2 Panel Wide Available (STD) 2 Sashes Above, (3 Light) 1 Sash Above, or (FXD) All Fixed Panels
- 3 Panel Wide Available (STD) 3 Sashes Above, or (FXD) All Fixed Panels
- 53mm Wideline Sash frame thickness as standard
- **Double Glazing option for all available sizes above**

 Not Available

# Boutique Single Transom (Contempo) Awning Windows

Code Prefix: WAAW Suite: BTP - ST



Size code			09	15	18	21
O/A Reveal Size (mm)			850	1450	1810	2170
Sash Height (mm)						
15	1543	460				
18	1800	545				
20	2057	631				
23	2315	525				

- 53mm Wideline Sash frame thickness as standard
- Double Glazing option for all available sizes above
- **Available in VIC & Sth NSW Only**

 Not Available

# Boutique Top Transom Awning Windows MKII

Code Prefix: WAAW Suite: BTP - TT

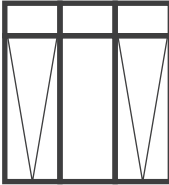
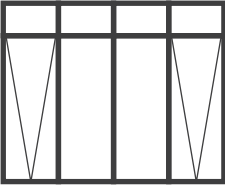
Size Code			06	09	12	12	15	18	21	24	15	18	21	24	27	18	21	24	27
	O/A Reveal Size (mm)		610	850	1210	1210	1450	1810	2170	2410	1450	1810	2170	2410	2710	1810	2170	2410	2710
	Sash Height (mm)																		
15	1543	1217																	
18	1800	1474																	
20	2057	1731																	

- Transom is positioned approximately 268mm from top of head to centre of transom, visible glass area will differ from the Standard range due to differences in the sections
- Single Panel Wide Available (STD) 1 Sash below Transom, or (FXD) All Fixed Panels
- 2 Panel Wide Available (STD) 1 Sash below Transom Left, (REV) 1 Sash below Transom Right, (DS) Double Sash below Transom, or (FXD) All Fixed Panels
- 3 Panel Wide Available (STD) Equal Panels with Sash Bottom Left and Sash Bottom Right, (TS) Equal Panels with 3 Sashes below Transom, (FXD) All Fixed Panels
- 4 Panel Wide Available (STD) Equal Panels with Sash Bottom Left and Sash Bottom Right, or (FXD) All Fixed Panels
- 53mm Wideline Sash frame thickness as standard
- **Double Glazing option for all available sizes above**

# Boutique Fixed No Mullion Awning Windows

Single Glazed

Code Prefix: WAAW Suite: BTP, FNM

Size Code		03	04	06	09	12	15	18	21	24	27	30	32	36	40	42	48
	O/A Reveal Size (mm)	330	450	610	850	1210	1450	1810	2170	2410	2710	3010	3250	3610	4000	4210	4810
05	514																
09	854																
10	1027																
12	1200																
14	1372																
15	1543																
18	1800																
20	2057																
21	2110																
23	2315																
24	2370																
27	2700																
30	3000																
40	4000																

Not Available

# Boutique Fixed No Mullion Awning Windows

Double Glazed

Code Prefix: WAAW Suite: BTP, FNM

Size Code		03	04	06	09	12	15	18	21	24	27	30	32	36	40	42	48
	O/A Reveal Size (mm)	330	450	610	850	1210	1450	1810	2170	2410	2710	3010	3250	3610	4000	4210	4810
05	514																
09	854																
10	1027																
12	1200																
14	1372																
15	1543																
18	1800																
20	2057																
21	2110																
23	2315																
24	2370																
27	2700																
30	3000																
40	4000																

- Available with any Glass Combination up to 18mm overall

 Not Available

# Boutique Fixed One Mullion Awning Windows

Single Glazed

Code Prefix: WAAW Suite: BTP, 1FM

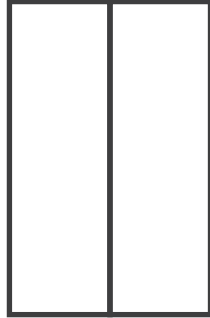
Size Code		06	09	12	15	18	21	24	27	30	32	36	40	42	48	60
	O/A Reveal Size (mm)	610	850	1210	1450	1810	2170	2410	2710	3010	3250	3610	4000	4210	4810	6000
05	514															
09	854															
10	1027															
12	1200															
14	1372															
15	1543															
18	1800															
20	2057															
21	2110															
23	2315															
24	2370															
27	2700															
30	3000															
40	4000															

 Not Available

# Boutique Fixed One Mullion Awning Windows

Double Glazed

Code Prefix: WAAW Suite: BTP, 1FM

Size Code		06	09	12	15	18	21	24	27	30	32	36	40	42	48	60
	O/A Reveal Size (mm)	610	850	1210	1450	1810	2170	2410	2710	3010	3250	3610	4000	4210	4810	6000
05	514															
09	854															
10	1027															
12	1200															
14	1372															
15	1543															
18	1800															
20	2057															
21	2110															
23	2315															
24	2370															
27	2700															
30	3000															
40	4000															

- Available with any Glass Combination up to 18mm overall

 Not Available

# Boutique Fixed Two Mullion Awning Windows

Single Glazed

Code Prefix: WAAW Suite: BTP, 2FM

Size Code		12	15	18	21	24	27	30	32	36	40	42	48	52	60
	O/A Reveal Size (mm)	1210	1450	1810	2170	2410	2710	3010	3250	3610	4000	4210	4810	5290	6000
05	514														
09	854														
10	1027														
12	1200														
14	1372														
15	1543														
18	1800														
20	2057														
21	2110														
23	2315														
24	2370														
27	2700														
30	3000														
40	4000														

Not Available



# Boutique Fixed Two Mullion Awning Windows

Double Glazed

Code Prefix: WAAW Suite: BTP, 2FM

Size Code		15	18	21	24	27	30	32	36	40	48	60
	O/A Reveal Size (mm)	1450	1810	2170	2410	2710	3010	3250	3610	4000	4810	6000
05	514											
09	854											
10	1027											
12	1200											
14	1372											
15	1543											
18	1800											
20	2057											
21	2110											
23	2315											
24	2370											
27	2700											
30	3000											
40	4000											

- Available with any Glass Combination up to 18mm overall

Not Available

# Boutique Fixed Three Mullion Awning Windows

Single Glazed

Code Prefix: WAAW Suite: BTP, 3FM

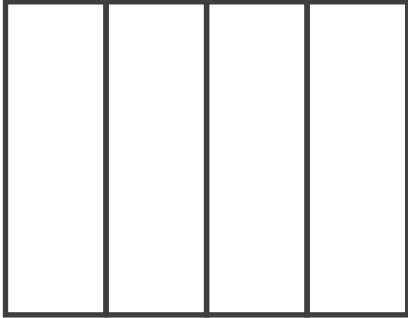
Size Code		15	18	21	24	27	30	32	36	40	42	48	52	60
	O/A Reveal Size (mm)	1450	1810	2170	2410	2710	3010	3250	3610	4000	4250	4810	5290	6000
05	514													
09	854													
10	1027													
12	1200													
14	1372													
15	1543													
18	1800													
20	2057													
21	2110													
23	2315													
24	2370													
27	2700													
30	3000													
40	4000													

 Not Available

# Boutique Fixed Three Mullion Awning Windows

Double Glazed

Code Prefix: WAAW Suite: BTP, 3FM

Size Code		15	18	21	24	27	30	32	36	40	42	48	60
	O/A Reveal Size (mm)	1450	1810	2170	2410	2710	3010	3250	3610	4000	4210	4810	6000
05	514												
09	854												
10	1027												
12	1200												
14	1372												
15	1543												
18	1800												
20	2057												
21	2110												
23	2315												
24	2370												
27	2700												
30	3000												
40	4000												

- Available with any Glass Combination up to 18mm overall

 Not Available

# Boutique & Standard Awning Windows

## Lineage Collection - Loft Series

Code Prefix: WAAW Colonial Bar Pattern: Loft

Size Code		03	06	09	12	15	18	21	24	27
O/A Reveal Size (mm)		330 (Fixed Only)	610	850	1210	1450	1810	2170	2398	2704
05	514									
09	854									
10	1027									
12	1200									
14	1372									
15	1543									
18	1800									
20	2057									
23	2315									







**Please Note:** Visible glass area between bars can vary in size across the same product, depending on product type, size and configuration. Speak to your A&L sales representative to find out more.

**Please Note:** Size charts are provided as a guide only, images may not reflect the exact proportions of the product you specify. Images represent the external view of the product and refer to A&L's standard offering for N2 areas. Specific size limitations or alternative options may be applicable for other wind categories or account customer specific ranges. The A&L website Terms of Use apply to this document. JWALNAT0546/0223 February 2023.

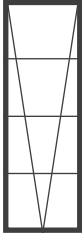
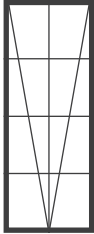
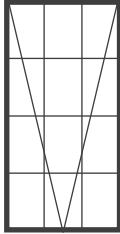
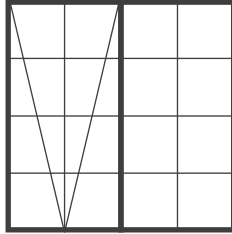
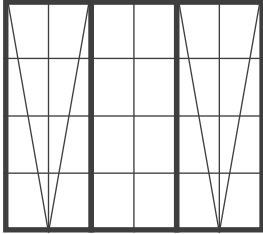
# Boutique & Standard Armadale Awning Windows

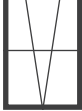
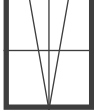
## Lineage Collection - Loft Series

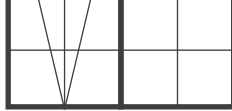
Code Prefix: WAAW Colonial Bar Pattern: Loft







Size Code		03	06	09	12	15	18	21	24	27
	O/A Reveal Size (mm)	330 (Fixed Only)	610	850	1210	1450	1810	2170	2398	2704
18	1800									
20	2057									
23	2315									

**Please Note:** Visible glass area between bars can vary in size across the same product, depending on product type, size and configuration. Speak to your A&L sales representative to find out more.

# Boutique & Standard Georgian Awning Windows

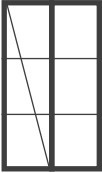
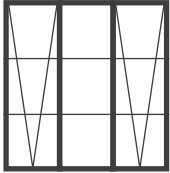
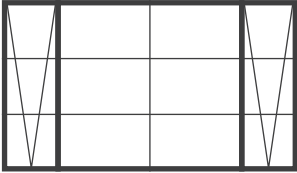
## Lineage Collection - Loft Series

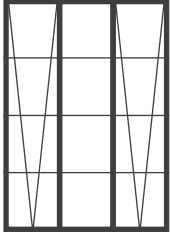
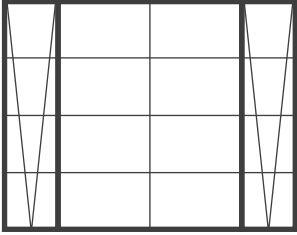
Code Prefix: WAAW Colonial Bar Pattern: Loft

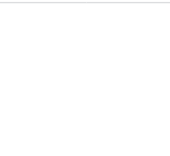
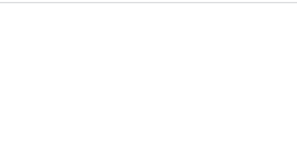
Size Code		09	12	15	18	21	24
O/A Reveal Size (mm)		850	1210	1450	1810	2170	2398
10	1027						
12	1200						
14	1372						
15	1543						
18	1800						
20	2057						
23	2315						

**Please Note:** Visible glass area between bars can vary in size across the same product, depending on product type, size and configuration. Speak to your A&L sales representative to find out more.





**Please Note:** Size charts are provided as a guide only, images may not reflect the exact proportions of the product you specify. Images represent the external view of the product and refer to A&L's standard offering for N2 areas. Specific size limitations or alternative options may be applicable for other wind categories or account customer specific ranges. The A&L website Terms of Use apply to this document. JWALNAT0546/0223 February 2023.

# Boutique & Standard Awning Windows

## Lineage Collection - Newport Series

Code Prefix: WAAW Colonial Bar Pattern: Newport

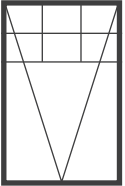
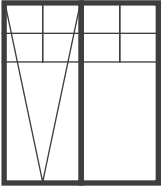
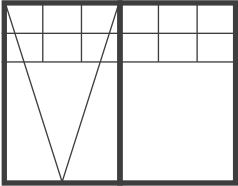
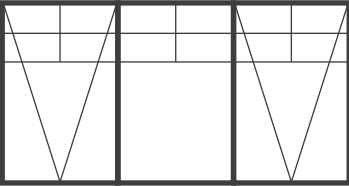
### Double

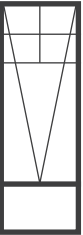
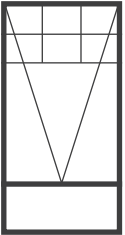
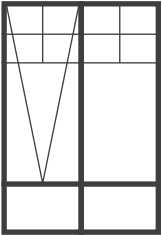
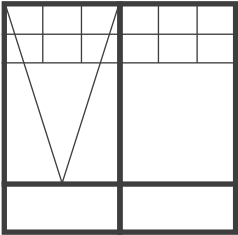
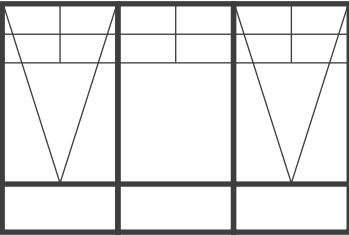
Size Code		03	06	09	12	15	18	21	24	27
O/A Reveal Size (mm)		330 (Fixed Only)	610	850	1210	1450	1810	2170	2398	2704
10	1027									
12	1200									
14	1372									
15	1543									
18	1800									
20	2057									
23	2315									

**Please Note:** Visible glass area between bars can vary in size across the same product, depending on product type, size and configuration. Speak to your A&L sales representative to find out more.

 Custom size, available upon request

**Please Note:** Size charts are provided as a guide only, images may not reflect the exact proportions of the product you specify. Images represent the external view of the product and refer to A&L's standard offering for N2 areas. Specific size limitations or alternative options may be applicable for other wind categories or account customer specific ranges. The A&L website Terms of Use apply to this document. JWALNAT0546/0223 February 2023.

# Boutique & Standard Awning Windows

## Lineage Collection - Newport Series

Code Prefix: WAAW Colonial Bar Pattern: Newport

### Single

Size Code		03	06	09	12	15	18	21	24	27
O/A Reveal Size (mm)		330 (Fixed Only)	610	850	1210	1450	1810	2170	2398	2704
09	854									
10	1027									
12	1200									
14	1372									
15	1543									
18	1800									
20	2057									
23	2315									

**Please Note:** Visible glass area between bars can vary in size across the same product, depending on product type, size and configuration. Speak to your A&L sales representative to find out more.



# Boutique Armadale Awning Windows

## Lineage Collection - Newport Series

Code Prefix: WAAW Colonial Bar Pattern: Newport

### Double

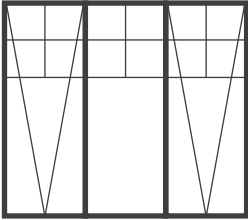
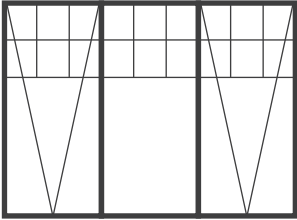
Size Code		18	21	24	27	30	36
	O/A Reveal Size (mm)	1810	2170	2410	2710	3010	3610
18	1800						
20	2057						
23	2315						

### Single

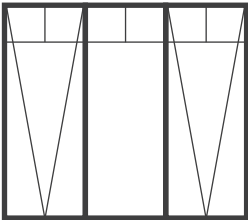
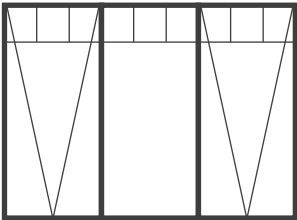
Size Code		18	21	24	27	30	36
	O/A Reveal Size (mm)	1810	2170	2410	2710	3010	3610
18	1800						
20	2057						
23	2315						

**Please Note:** Visible glass area between bars can vary in size across the same product, depending on product type, size and configuration. Speak to your A&L sales representative to find out more.





**Please Note:** Size charts are provided as a guide only, images may not reflect the exact proportions of the product you specify. Images represent the external view of the product and refer to A&L's standard offering for N2 areas. Specific size limitations or alternative options may be applicable for other wind categories or account customer specific ranges. The A&L website Terms of Use apply to this document. JWALNAT0546/0223 February 2023.

# Boutique Georgian Awning Windows



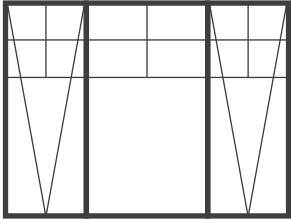
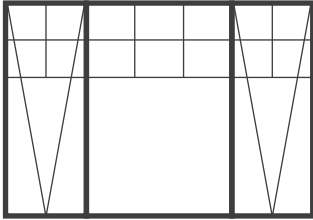
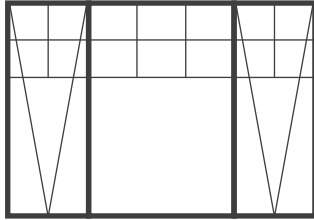
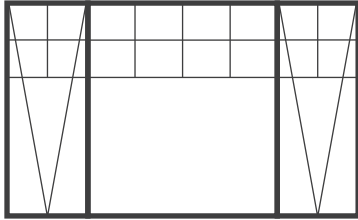
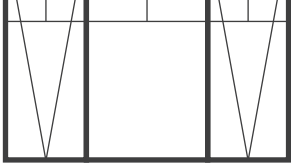
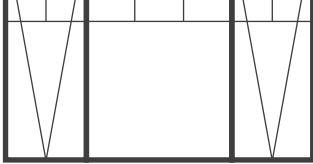
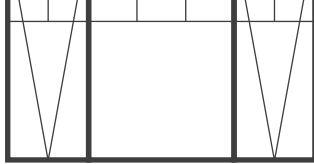
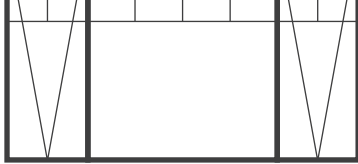



## Lineage Collection - Newport Series

Code Prefix: WAAW Colonial Bar Pattern: Newport

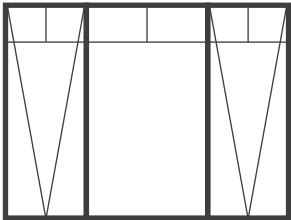
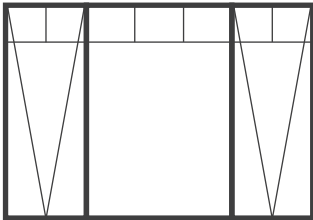
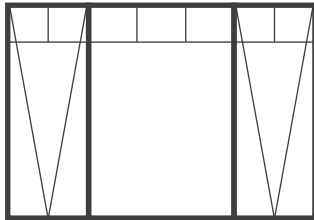
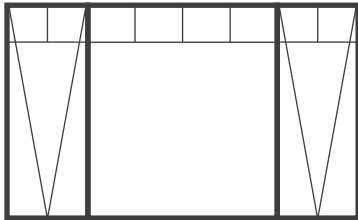
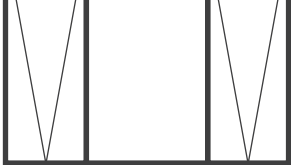
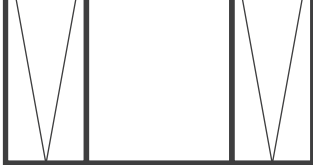
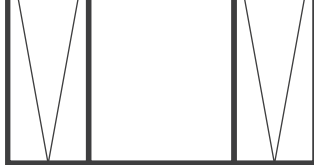
### Double

Size Code		18	21	24	27	30	36
	O/A Reveal Size (mm)	1800	2170	2410	2710	3010	3610
18	1800						
20	2057						
23	2315						

### Single

Size Code		18	21	24	27	30	36
	O/A Reveal Size (mm)	1800	2170	2410	2710	3010	3610
18	1800						
20	2057						
23	2315						

**Please Note:** Visible glass area between bars can vary in size across the same product, depending on product type, size and configuration. Speak to your A&L sales representative to find out more.

**Please Note:** Size charts are provided as a guide only, images may not reflect the exact proportions of the product you specify. Images represent the external view of the product and refer to A&L's standard offering for N2 areas. Specific size limitations or alternative options may be applicable for other wind categories or account customer specific ranges. The A&L website Terms of Use apply to this document. JWALNAT0546/0223 February 2023.

# Boutique & Standard Awning Windows

## Lineage Collection - Gatsby Series

Code Prefix: WAAW Colonial Bar Pattern: Gatsby

Size Code		03	06	09	12	15	18	21	24	27
O/A Reveal Size (mm)		330 (Fixed Only)	610	850	1210	1450	1810	2170	2398	2704
05	514									
09	854									
10	1027									
12	1200									
14	1372									
15	1543									
18	1800									
20	2057									
23	2315									









**Please Note:** Visible glass area between bars can vary in size across the same product, depending on product type, size and configuration. Speak to your A&L sales representative to find out more.

**Please Note:** Size charts are provided as a guide only, images may not reflect the exact proportions of the product you specify. Images represent the external view of the product and refer to A&L's standard offering for N2 areas. Specific size limitations or alternative options may be applicable for other wind categories or account customer specific ranges. The A&L website Terms of Use apply to this document. JWALNAT0546/0223 February 2023.

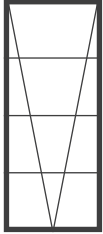
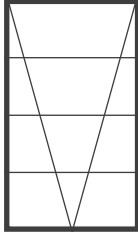
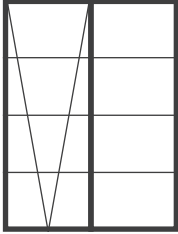
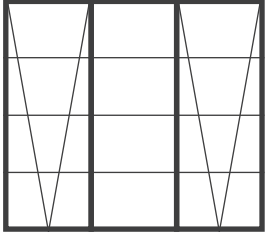
# Boutique & Standard Armadale Awning Windows

## Lineage Collection - Gatsby Series

Code Prefix: WAAW Colonial Bar Pattern: Gatsby











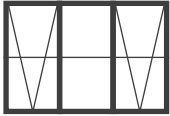



Size Code		03	06	09	12	15	18	21	24	27
	O/A Reveal Size (mm)	330 (Fixed Only)	610	850	1210	1450	1810	2170	2398	2704
18	1800									
20	2057									
23	2315									

**Please Note:** Visible glass area between bars can vary in size across the same product, depending on product type, size and configuration. Speak to your A&L sales representative to find out more.

# Boutique & Standard Georgian Awning Windows

## Lineage Collection - Gatsby Series

Code Prefix: WAAW Colonial Bar Pattern: Gatsby

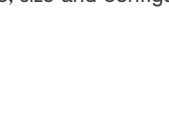
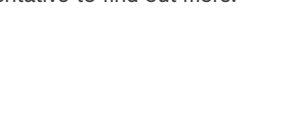
Size Code		09	12	15	18	21	24
O/A Reveal Size (mm)		850	1210	1450	1810	2170	2398
10	1027						
12	1200						
14	1372						
15	1543						
18	1800						
20	2057						
23	2315						

**Please Note:** Visible glass area between bars can vary in size across the same product, depending on product type, size and configuration. Speak to your A&L sales representative to find out more.

**Please Note:** Size charts are provided as a guide only, images may not reflect the exact proportions of the product you specify. Images represent the external view of the product and refer to A&L's standard offering for N2 areas. Specific size limitations or alternative options may be applicable for other wind categories or account customer specific ranges. The A&L website Terms of Use apply to this document. JWALNAT0546/0223 February 2023.